

HOIST CHAINS

for manual and motor-driven hoists

ENG
EDITION_3



HOIST CHAINS

for manual and
motor-driven hoists

FOR US, THERE IS ONLY ONE OBJECTIVE: BEING BETTER.

Advantages „being better“	2
Hoist chains performance/ applications	3
DAT type, case-hardened	4
D-profil-chain DAT type	5
T type, tempered	6
VH type, tempered hand chains	7
Version RPA/RSA, rust-free	8
Corrosion protection coatings Standard packing	9
RUD portal	10
Test certificate - RUD hoist chains	11
Wheels and guides	12
Limit gauge	13
Requirements on hoist chains	14
Lubricants/ recommended lubricants	14

CHAIN HARDNESS

Uniform surface hardness and depth, particularly in the joints, excellent wear resistance, long service life.

GEOMETRY

Narrow dimensional tolerances, symmetrical link shape, fine control using take-up wheels.

CALIBRATION

All RUD hoist chains are 100% calibrated.

PRODUCTION

Made in Germany, at our Aalen-Unterkochen plant.

DEVELOPMENT

Collaboration with German technical institutes and hoist equipment manufacturers.

STRENGTH

Outstanding dynamic strength, maximum operating safety.

IDENTIFICATION

Chain identification is essential for clear safety information and traceability.

CHAIN DIMENSIONS

RUD makes the smallest and largest hoist chains in the world, with sizes ranging from 3 x 9 to 32 x 90 mm.

SERVICE

Reliable delivery, consultation and technical assistance worldwide from our RUD representatives.

**WE SUPPLY ALL LEADING OEMS WORLDWIDE
WITH OUR RUD HOIST CHAINS - MADE IN
GERMANY**

HOIST CHAINS

for manual and motor-driven hoists

RUD HOIST CHAINS: PERFORMANCE - OVERVIEW

1. Raw materials



Available in a variety of qualities and sizes on coil or as rods.

2. Drawing the wire



The drawing machine draws the material to precisely the desired diameter.

3. Bending



Bending of the individual chain links: Each link is cleanly bent and laced into the next link.

4. Welding



Welding the links after bending.

5. Stamping



Stamping the welded chain with critical information: The RUD emblem, quality rating, manufacturing number and batch number.

6. Heat treatment



Case-hardened and quenched and tempered chains

7. Surface treatment



Black phosphated, galvanised, special coatings

8. Final calibration



The chain is precisely sized and loaded with manufacturing proof force.

9. Final acceptance



Quality assurance and acceptance.

10. Lubrication and packing



Warehousing and shipping.

APPLICATION FOR RUD HOIST CHAINS: INDUSTRY · WIND POWER STATIONS · STAGE TECHNOLOGY · OFFSHORE



RUD ROUND LINK CHAIN – DAT TYPE

FOR HIGH WEAR RESISTANCE PER EN 818-7-DAT,
USING MOTOR-DRIVEN HOISTS

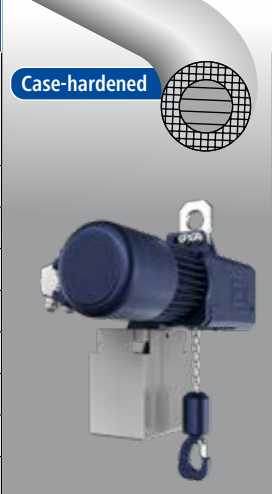
DAT/T quality class execution			 <p>Case-hardened</p>	Quality and designation			RTS	RTD	RTB
Mechanism group ISO 4301-1 (FEM 9.511)	Nominal stress [N/mm ²]	Limit stress [N/mm ²]		Stress at manufacturing proof force	σ_{FPmin}	N/mm ²	500		
M1 (1Dm)	200	250		Stress at breaking force	σ_{Bmin}	N/mm ²	800		
M2 (1Cm)	160	225		Total ultimate elongation	A_{min}	%	10		
M3 (1Bm)	160	200		Surface hardened according to DIN EN 818-7	$d \leq 6,5 \varnothing$ $d \geq 7 \varnothing$	HV 5 HV10	500 - 650		
M4 (1Am)	140	180		Case depth in the joint (after macro-etching)	$\dots d$ $\pm 0.01 d$	mm	$\leq \varnothing 4 / 0.05$ $\varnothing 4.1-7 / 0.04$ $\varnothing 8-16 / 0.03$ $\geq \varnothing 16.1 / 0.02$	$< \varnothing 8 / 0.05$ $\varnothing 8-11.5 / 0.04$ $\geq \varnothing 12 / 0.03$	
M5 (2m)	125	160		Fatigue strength		N/mm ²	130 ± 80	130 ± 90	130 ± 100
M6 (3m)	112	140							
M7 (4m)	100	125							
M8 (5m)	90	112							

Dimensions [mm]	Material No.	Load capacity F _{tr} [kg] according to mechanism group				Manufacturing proof force FFPmin [kN]	Breaking force FBmin [kN]	RTS	RTD	RTB	Weight [kg/m]
		M3 (1Bm)	M4 (1Am)	M5 (2m)	M6 (3m)						
		Nominal stress: 160 N/mm ²	Nominal stress: 140 N/mm ²	Nominal stress: 125 N/mm ²	Nominal stress: 112 N/mm ²						
		Safety factor 5	Safety factor 5.7	Safety factor 6.4	Safety factor 7.1						
3 ¹⁾ x 9	7985902	230	200	180	160	7	11.3	x			0.19
4 x 12	7100183	410	350	320	280	12.6	20.1	x	x	x	0.35
5 x 15	7100184	640	560	500	440	19.6	31.4	x	x	x	0.54
6 x 18	7101362	920	800	720	640	28.3	45.2	x	x		0.78
6.3 x 19	7983648	1,000	880	790	710	31.2	49.9	x			0.86
6.3 x 19.1	7102922	1,000	880	790	710	31.2	49.9	x			0.86
7 x 21	7102168	1,250	1,090	980	870	38.5	61.6	x	x	x	1.1
7 x 22	7100185	1,250	1,090	980	870	38.5	61.6	x	x		1.1
7.1 x 20.2	7103637	1,250	1,090	980	870	39.6	63.3	x		x	1.1
7.1 x 21.2	7102924	1,290	1,130	1,000	900	39.6	63.3	x			1.1
8 x 24	7101363	1,640	1,430	1,280	1,140	50.3	80.4	x			1.4
9 x 27	7100186	2,070	1,810	1,620	1,450	63.6	102	x	x	x	1.8
10 x 28	7102169	2,560	2,240	2,000	1,790	78.5	126	x			2.2
10 x 30.2	7102926	2,560	2,240	2,000	1,790	78.5	126	x			2.2
11 x 31	7102955	3,100	2,700	2,420	2,160	95	152	x			2.7
11.2 x 34	7993063	3,200	2,800	2,500	2,240	98.5	157.6	x			2.7
11.2 x 34.4	7102930	3,200	2,800	2,500	2,240	98.5	157.6	x			2.7
11.3 x 31	7992923	3,270	2,860	2,550	2,280	100.3	160.5	x	x	x	2.85
13 x 36	59733	4,330	3,780	3,380	3,030	132.7	212.3	x		x	3.8
16 x 45	55004	6,550	5,730	5,120	4,590	201	322	x		x	5.7
23.5 ¹⁾ x 66	7993516	14,100	12,370	11,000	9,900	434	694	x			12.2

¹⁾ Dimensions outside of EN 818-7. Other dimensions on request.

The nominal stresses, and the limit stresses may not exceed the stresses specified in the respective mechanism groups. Operating temperature - 20° C to + 200° C.

RUD D-PROFILE-CHAIN – DAT TYPE

FOR HIGH WEAR RESISTANCE PER EN 818-7-DAT,
USING MOTOR-DRIVEN HOISTS

DAT/T quality class execution			Quality and designation			RTS	RTD	RTB	
Mechanism group ISO 4301-1 (FEM 9.511)	Nominal stress [N/mm ²]	Limit stress [N/mm ²]							
M1 (1Dm)	200	250	 <p>Case-hardened</p>	Stress at manufacturing proof force	σ_{FPmin}	N/mm ²	500		
M2 (1Cm)	160	225		Stress at breaking force	σ_{Bmin}	N/mm ²	800		
M3 (1Bm)	160	200		Total ultimate elongation	A_{min}	%	10		
M4 (1Am)	140	180		Surface hardness according to DIN EN 818-7	$d \leq 6,5 \varnothing$ $d \geq 7 \varnothing$	HV 5 HV10	500 - 650		
M5 (2m)	125	160		Case depth in the joint (after macro-etching)	$\dots d$ $\pm 0.01 d$	mm	$\leq \varnothing 4 / 0.05$ $\varnothing 4.1-7 / 0.04$ $\varnothing 8-16 / 0.03$ $\geq \varnothing 16.1 / 0.02$	$< \varnothing 8 / 0.05$ $\varnothing 8-11.5 / 0.04$ $\geq \varnothing 12 / 0.03$	
M6 (3m)	112	140		Fatigue strength		N/mm ²	130 ± 80	130 ± 90	130 ± 100
M7 (4m)	100	125							
M8 (5m)	90	112							

Dimensions [mm]	Quality	Material No.	Load capacity F _{tr} [kg] according to mechanism group				Manu- facturing proof force FFPmin [kN]	Breaking force FBmin [kN]	Manufacturing length	Weight [kg/m]
			M3 (1Bm)	M4 (1Am)	M5 (2m)	M6 (3m)				
			Nominal stress: 160 N/mm ²	Nominal stress: 140 N/mm ²	Nominal stress: 125 N/mm ²	Nominal stress: 112 N/mm ²				
			Safety factor 5	Safety factor 5.7	Safety factor 6.4	Safety factor 7.1				
3.7 x 12	RTD	7907103	380	340	320	270	12.6	20.1	200 m	0.34
3.75 x 10.75	RTS	7909389	380	340	320	270	12.6	20.1	200 m	0.34
5 x 14.3	RTD	7907401	630	600	540	480	21.3	34.0	200 m	0.61
5.25 x 15	RTS	7908823	800	670	630	530	24.7	39.5	200 m	0.59
7 x 21	RTD	7903473	1,400	1,220	1,090	970	43	68.8	100 m	1.20
7.45 x 23	RTS	7909391	1,540	1,350	1,200	1,080	50	80	150 m	1.35
9.6 x 30	RTD	7907402	2,560	2,240	2,000	1,790	78.5	126	100 m	2.15

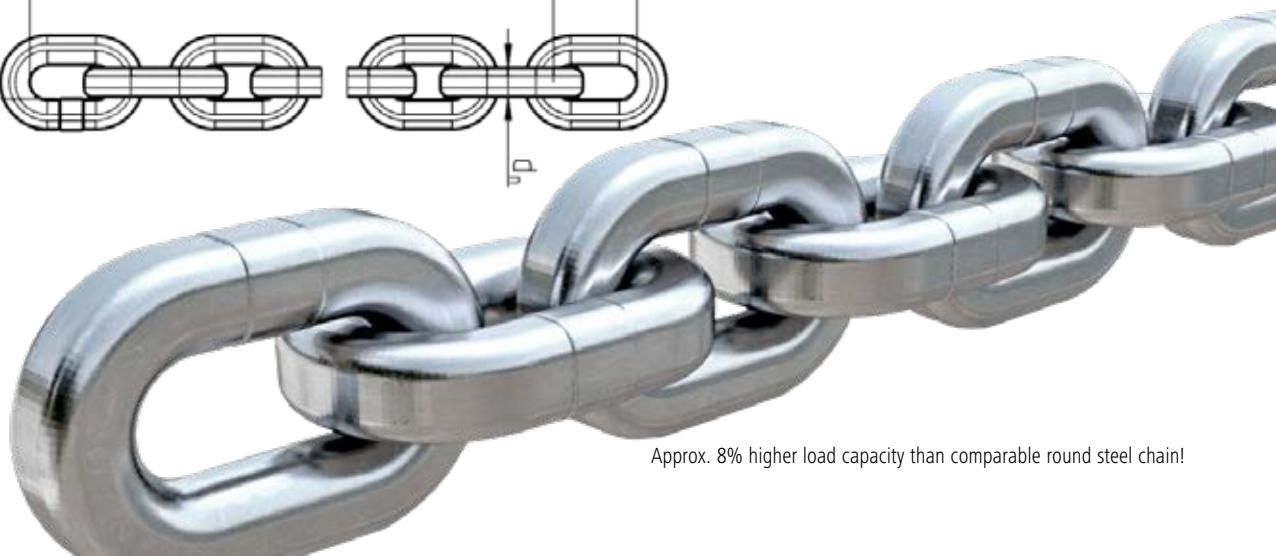
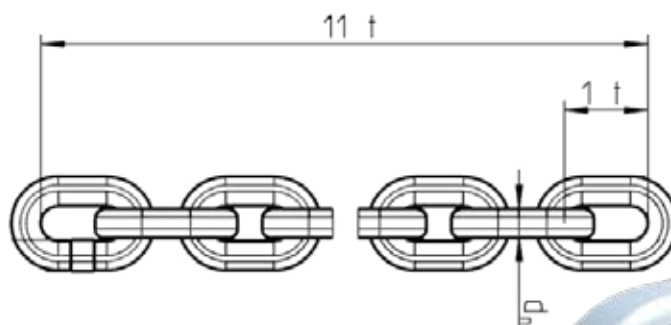
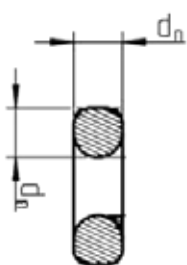

Approx. 8% higher load capacity than comparable round steel chain!

RUD HOISTING CHAINS - T TYPE

FOR LOW/MODERATE WEAR APPLICATIONS PER EN 818- 7-T,
SPECIAL DESIGNED FOR MANUAL HOISTS

Quality and designation			RT	
 Quenched and tempered	Stress at manufacturing proof force	σ_{FPmin}	N/mm ²	500
	Stress at breaking force	σ_{Bmin}	N/mm ²	800
	Total ultimate elongation	A_{min}	%	10
	Surface hardness in the joint		HV10	360

Dimensions [mm]	Material No.	Load capacity F_{Tr} [kg] according to mechanism group					Manufacturing proof force FFP_{min} [kN]	Breaking force FB_{min} [kN]	Weight [kg/m]
		Hand (1Dm)	M3 (1Bm)	M4 (1Am)	M5 (2m)	M6 (3m)			
		Nominal stress: 200 N/mm ² Safety factor 4	Nominal stress: 160 N/mm ² Safety factor 5	Nominal stress: 140 N/mm ² Safety factor 5.7	Nominal stress: 125 N/mm ² Safety factor 6.4	Nominal stress: 112 N/mm ² Safety factor 7.1			
3 ¹⁾ x 9	7989206	280	230	140	180	160	7	11.3	0.19
4 x 12	53804	510	410	350	320	280	12.6	20.1	0.35
4.2 x 12.2	7983725	560	440	390	350	310	13.8	22.0	0.38
5 x 15	53008	800	640	560	500	440	19.6	31.4	0.54
5.6 x 15.8	7990657	1,000	800	700	630	560	24.6	39.4	0.70
5.6 x 17	57165	1,000	800	700	630	560	24.6	39.4	0.68
6 x 18	56680	1,150	920	800	720	640	28.3	45.2	0.78
6 x 18.5	60144	1,150	920	800	720	640	28.3	45.2	0.8
6.3 x 19	7985347	1,270	1,010	880	790	710	31.2	49.9	0.86
6.3 x 19.1	53012	1,270	1,010	880	790	710	31.2	49.9	0.86
7 x 22	7901147	1,560	1,250	1,090	980	870	38.5	61.6	1.1
7.1 x 20.1	7990660	1,560	1,250	1,090	980	870	39.6	63.3	1.09
7.1 x 21	53016	1,560	1,250	1,090	980	870	39.6	63.3	1.1
7.1 x 21.2	62168	1,560	1,250	1,090	980	870	40	67	1.1
8 x 24	62162	2,050	1,640	1,430	1,280	1,140	50.3	80.4	1.4
9 x 24.8	7990664	2,590	2,070	1,810	1,620	1,470	63.6	102.0	1.82
9 x 27	55376	2,590	2,070	1,810	1,620	1,470	63.6	102	1.8
10 x 28	7101451	3,200	2,560	2,240	2,000	1,790	78.5	126	2.2
10 x 28.1	7990789	3,200	2,560	2,240	2,000	1,790	78.5	126.0	2.23
10 x 30	57862	3,200	2,560	2,240	2,000	1,790	78.5	126	2.2
11 x 31	60931	3,870	3,100	2,710	2,420	2,170	95	152	2.7
11.2 x 34	53028	4,010	3,200	2,810	2,500	2,250	98.5	157.6	2.7
13 x 36	53030	5,400	4,320	3,780	3,380	3,030	132.7	212.3	3.8
16 x 45	53017	8,150	6,550	5,730	5,110	4,590	201	322	5.7
22 x 66	7989369	15,500	12,500	10,840	9,680	8,680	400	630	10.7
23.5 ¹⁾ x 66	7992988	17,680	14,140	12,380	11,050	9,900	434	694	12.2
32 ¹⁾ x 90	7993904	32,790	26,200	22,950	20,480	18,360	780	1,286	21.3

¹⁾ Dimensions outside of above mentioned standards. Other dimensions on request.

The nominal stresses and the limit stresses may not exceed the stresses specified in the respective mechanism groups. Operating temperature - 40° C to + 200° C

RUD ROUND LINK CHAIN – VH TYPE

FOR USE IN MANUAL HOISTS

ISO 16872

 Quenched and tempered	Quality and designation			VH
	Stress at manufacturing proof force	σ_{FPmin}	N/mm ²	625
	Stress at breaking force	σ_{Bmin}	N/mm ²	1000
	Total ultimate elongation	A_{min}	%	17
	Surface hardness in the joint		HV10	min. 430

Dimensions [mm]	Material No. „natural black“	Load capacity F_{Tr} [kg] according to mechanism group		Manufacturing proof force F_{FPmin} [kN]	Breaking force F_{Bmin} [kN]	Weight [kg/m]
		Load traction force: 250 N/mm ²				
		Safety factor 4				
4 x 12	7905884	630		15.7	25.1	0.35
5 x 15	7900678	1,000		24.5	39.3	0.54
6.3 x 19.1	7900646	1,600		39.0	62.3	0.86
7.1 x 21	7901086	2,000		49.5	79.2	1.1
8 x 24	7900679	2,500		62.8	101	1.4
9 x 27	7900680	3,150		79.5	127	1.8
10 x 30	7900925	4,000		98.2	157	2.2
10 x 30.2	7901061	4,000		98.2	157	2.2

Chains in accordance with ISO 16872 may only be installed/used in manually operated hoists.
Operating temperature - 40° C to + 150° C.

RUD HAND CHAINS – FOR MANUAL HOIST

Galvanised hand chain, not certificated		
Dimensions	Designation	P/n [100 m length]
5 x 18.5	galvanised hand chain	8502628
5 x 23.5	galvanised hand chain	8502627
5 x 23.8	galvanised hand chain	8502970
5 x 24	galvanised hand chain	8502626
5 x 25	galvanised hand chain	8502563
5 x 25.2	galvanised hand chain	8502629
5 x 26	galvanised hand chain	8502632
6 x 18.7	galvanised hand chain	8501629
5 x 18.5	open chain link	7101773
5 x 24	open chain link	7101770
5 x 25	open chain link	59381

1.4404 stainless steel hand chain, not certificated		
Dimensions	Designation	P/n
5 x 18.5	stainless steel hand chain	63656
5 x 24	stainless steel hand chain	7103866
5 x 25	Stainless steel hand chain	53943
5 x 25.2	stainless steel hand chain	62473
5 x 18.5	open chain link	8500193
5 x 25	open chain link	8500194



RUD ROUND LINK CHAIN RUST AND ACID RESISTANT QUALITY

SIMILAR TO DIN 5684 PARTS 1 AND 2,
FOR MOTOR-DRIVEN AND MANUAL HOISTS



Quality classes RPA and RSA				
Mechanism group ISO 4301-1 (FEM 9.511)	Nominal stress: [N/mm ²]		Limit stress [N/mm ²]	
	RPA	RSA	RPA	RSA
M1 (1Dm)	125	160	187,5	240
M2 (1Cm)	100	125	138	175
M3 (1Bm)	100	125	125	160
M4 (1Am)	90	112	112	140
M5 (2m)	80	100	100	125
M6 (3m)	70	90	90	112
M7 (4m)	60	80	80	100
M8 (5m)	55	70	70	90

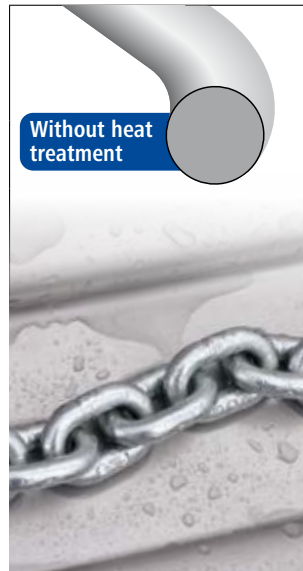

Quality and designation			Quality class P RPA	Quality class S RSA
Material			AISI 316	
Stress at manufacturing proof force	σ_{FPmin}	N/mm ²	315	400
Stress at breaking force	σ_{Bmin}	N/mm ²	500	630
Total ultimate elongation	A _{min}	%	15	
Surface hardness in the joint	d ≤ 6.5 Ø d ≤ 7 Ø	HV 5 HV10	Approx. 250	





Dimen- sions [mm]	Material No.	Quality class	Load capacity F _{tr} [kg] according to mechanism group					Manu- factu- ring proof force FFPmin [kN]	Brea- king force FBmin [kN]	Weight [kg/m]
			Hand (1Dm)	M3 (1Bm)	M4 (1Am)	M5 (2m)	M6 (3m)			
			Nominal stress: ≤ Ø 7 = 160 N/mm ² ≥ Ø 8 = 125 N/mm ²	Nominal stress: ≤ Ø 7 = 125 N/mm ² ≥ Ø 8 = 100 N/mm ²	Nominal stress: ≤ Ø 7 = 110 N/mm ² ≥ Ø 8 = 90 N/mm ²	Nominal stress: ≤ Ø 7 = 100 N/mm ² ≥ Ø 8 = 80 N/mm ²	Nominal stress: ≤ Ø 7 = 90 N/mm ² ≥ Ø 8 = 70 N/mm ²			
			Safety factor 4	Safety factor 5	Safety factor 5.7	Safety factor 6.4	Safety factor 7.1			
4 x 12	54079	S	400	320	280	250	230	10	16	0.35
5 x 15	54100	S	630	500	440	400	360	16	25	0.54
6 x 18	54333	S	900	720	630	570	510	22.4	36	0.78
6.3 x 19.1	53998	S	1,010	790	700	635	570	25	40	0.86
7 x 21	54130	S	1,250	1,000	860	780	700	32	50	1.1
8 x 24	58778	P	1,250	1,000	920	820	710	32	50	1.4
9 x 27	58779	P	1,600	1,250	1,160	1,000	900	40	63	1.8
10 x 28	58780	P	2,000	1,600	1,440	1,250	1,120	50	80	2.2
10 x 30	52303	P	2,000	1,600	1,440	1,250	1,120	50	80	2.2
11.3 x 31	7984841	P	2,500	2,000	1,800	1,600	1,400	63	100	2.85
13 x 36	58784	P	3,350	2,650	2,430	2,100	1,890	85	132	3.8
16 x 45	7988746	P	5,000	4,000	3,680	3,270	2,860	125	200	5.7

Other dimensions
on request.

The nominal stresses and the limit stresses
may not exceed the stresses specified
in the respective mechanism groups.

Attention: Because of the austenitic materials with low hardness,
reduction of the nominal stress and good lubrication of the chain will
produce a satisfactory service life.
For continuous operation, a nominal stress of $\sigma_{tr} = 80$ N/mm² should
not be exceeded for motor-driven hoists.

CORROSION PROTECTION COATINGS FOR RUD HOIST CHAINS

Surfaces	Short description of surface coating	New condition
Natural dark blue oil polished	Thick oxide layer with corrosion protection oil	
Phosphated oil polished (POP)	Zinc phosphate with corrosion protection oil (5 µm)	
Electrolytic galvanised	Electrolytic metal deposition	
Corrud-DT coating	Inorganic zinc-plated coating with a combination of zinc and aluminium plates	
Topcoat SI	An organic high networked micro layer with prevailing ingredients of aluminum and epoxy resin	

STANDARD PACKING RUD HOIST CHAINS



- Disposable packaging RUD 1: 80 x 60 x 55 cm
- Disposable packaging RUD 2: 80 x 60 x 75 cm
- Disposable packaging RUD 3: 80 x 60 x 95 cm

Including VCI film for each packaging size.



RUD PORTAL FOR RUD HOIST CHAINS

THE RUD PORTAL IS OUR SECURE PLATFORM FOR OUR CUSTOMERS WITH ACCESS TO INFORMATION AND APPLICATIONS.

In our RUD portal, you will find everything you need for a safe and efficient use of hoist chains: from easy-to-understand operating instructions for the proper use of hoist chains to lubricant recommendations that optimize the lifespan of your chains. Discover our products in detailed product presentations and use our discard criteria to determine the wear level of your hoist chains. Our catalogs provide you with a comprehensive overview of our range of hoist chains and ensure that you are always up-to-date.



Easy registration:



www2.rud.com

or by email to:

hoistchains@rud.com

More information about RUD
hoist chains at:

www.hoistchains.rud.com



TEST CERTIFICATE FOR RUD HOIST CHAINS

UNIQUELY TRACEABLE FROM THE CUSTOMER TO THE STEEL MILL

Thanks to the RUD test certificate and the clearly identifiable stamping, RUD hoist chains guarantee 100% traceability. In addition to the chain type and quality, the production number (e.g., D24) and batch number (e.g., 002) are stamped on each chain. These numbers form the clearly identifiable manufacturing number printed on the test certificate. With these numbers we guarantee the clear allocation of the inspections and tests at RUD. Thus, we create a further security feature.

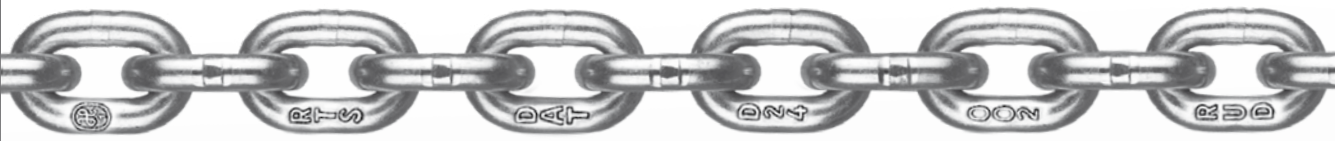

Official company inspection stamp Chain type Quality denomination Serial no. Batch no. Manufacturer

Kommanditgesellschaft
Sitz Aalen-Unterkochen
Amtsgericht Ulm
HRA 500160

Komplementärin
RUD-Kettenfabrik
Gebr. Rieger GmbH
Sitz Aalen-Unterkochen
Amtsgericht Ulm
HRB 600066

Geschäftsführer:
Dr. Hansjörg Rieger
Jörg S. Rieger, Ph.D.
Johannes W. Rieger
Benjamin T. Rieger

RUD Ketten Rieger & Dietz GmbH u. Co. KG D-73428 Aalen, Germany Certified acc. to ISO 9001 and ISO 14001

S A M P L E !!
=====

customer order no.: XXXXXX
from: XXXXXX
our ref.:HR/JSR/TEQ/
telephone: 07361/504-
Aalen, 01.03.2015
RUD order no.: XXX
cert.-No.: XXX
quant. desp.: XXXX
weight: XX

serial-no.: XXXXXX

Inspection Certificate 3.1 acc. to DIN EN 10204

description: chain 4,00 x 12,20 RUD ref.
quality grade: T customer ref.:
type: DAT
quality: RTS
material: special chain steel
condition of surface: galvanized

working load limit / stress at working load limit:

XXXX	XXXX
XXXXXXXXXX	XXXXXXXXXX
XXX	XXX

- **Grade designation + design**
Grade designation according to standard DIN EN 818-7 or according to other standards for hoist chains.
- **Quality**
The RUD quality designation.
- **Production and batch number**
RUD production and batch number for clear traceability of the chain.

RUD wheels and guides are the optimum solution for every hoist. Classic pocket wheels and X-drive wheels from RUD have optimally matched pocket numbers and are individually adapted to each customer requirement. RUD chain guides complement the portfolio and ensure a fully comprehensive complete package for every hoist.

Proven RUD design and know-how in the construction and production of chains, wheels and guides make the difference.

We also design and produce wheels and guides for any hoist, regardless of the chain used.

INFORMATION REQUIRED FOR ORDERING RUD POCKET CHAIN WHEELS:

- Chain dimensions and number of pockets
- Hub length E + C
- Drill-Ø D with fit (if no details are given, fit H7 and bore chambers 1.5 x 45° are used)
- Groove for feather key DIN 6885 Bl. 1 P9 or IS9 or keyway with details about key insertion direction
- Possibly threaded hole for set screw with indication of position

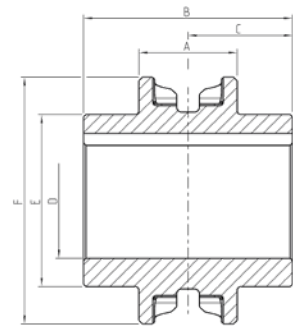
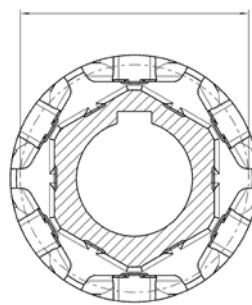

Chain d x t [mm]	Number of pockets	Pitch circle Ø	Crown width A	Max. boring B
5 x 15	5	48	25	20
7 x 21	6	81	35	40
9 x 27	6	104	45	50
13 x 36	6	139	65	70
16 x 45	6	174	80	90
23.5 x 66	5	212	88	95

Further wheel types available on request. The design and selection of shaft/hub coupling must be handled by the plant manufacturer in relation to the forces in play. Recommendation: $E \approx 1.7 \times B$

INDIVIDUALLY ADJUSTABLE FOR EVERY WHEEL AND EVERY CUSTOMER REQUEST.

- Chain dimension required for determination
- Pocket wheel required for determination

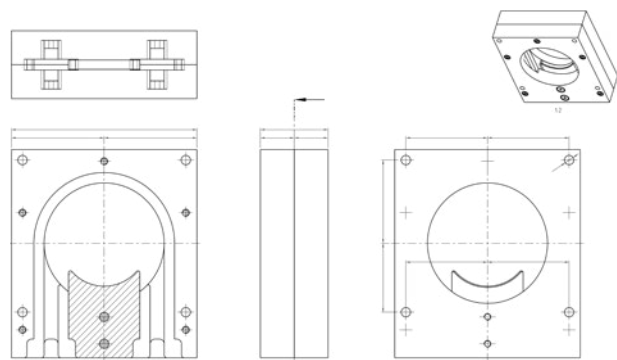

RUD LIMIT GAUGE FOR HOIST CHAINS

Manufacturer	Motor driven hoist	Manual driven hoist	Material No.
CM / Yale		×	7993866
CM / Yale	×		7996272
DEMAG (DK / DC + PK)	×		7101452
GIS	×		51622
HADEF		×	7995835
HADEF (AK + GEDI)	×		7900303
KITO		×	7994684
LIFTKET	×		7992010
J.D. NEUHAUS	×		62540
R.STAHL / STAHL CRANESYSTEMS	×		7994103
TIGER (T + VH)		×	7907394
VERLINDE / KONE / SWF	×		7993092
ABUS	×		7909386

...SIMPLE SETUP FOR FAST RESULTS...



- Our RUD limit gauge consists of a sturdy aluminium strip with guide holes for the measuring pins as well as locking holes for the locking studs attached to the measuring pin.
- The size of the chain to be tested – $d_n \times t$ – is engraved below the guide holes.

The two galvanised measuring pins provided with locking studs are located, together with the limit gauge, in a high quality softshell pocket.

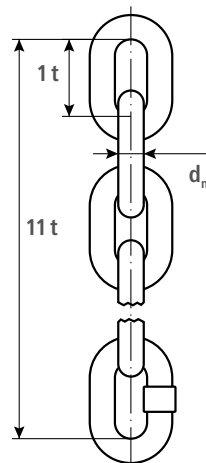

d_n = Nominal diameter
 t = Inner pitch attachment
 11 t = Length over 11 links

More information about the RUD limit gauge in our brochure or in RUD Portal.

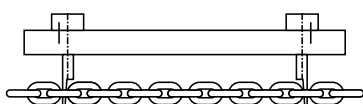

Gauge to be introduced: chain is alright

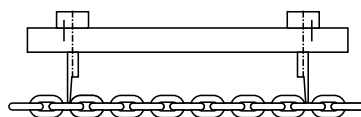

Gauge cannot be introduced: chain has to be replaced wear > 2 % respectively 3 %

REQUIREMENTS ON RUD HOIST CHAINS

LOADS · HARDNESS · WEAR

DYNAMIC CHAIN LOADING

Requirements per DIN EN 818-7

RUD meets the challenge of dynamic chain loading with the most modern fabrication and testing methods.

Example of dynamic chain loading in the hoist during the lifting cycle

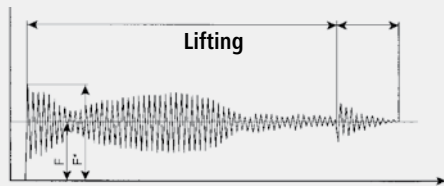

Dynamic chain testing in the pulsator

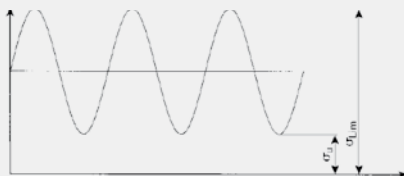

Traction relationship $R = \frac{\sigma_{tr}}{\sigma_o} = 0.2$
 Limit vibration $n = 2 \times 10^6$
 Permitted limit traction $= \sigma_o = \sigma_{lim}$

WEAR TESTING

Parameter:

Load traction $\sigma_{tr} = 100 \text{ N/mm}^2$
 Pocket number $Z = 5$
 Speed $v = 8 \text{ m/min.}$
 Dry, ungreased chain
 1 chain

A well lubricated chain and properly designed chain drive make for several times higher load alternation. As a rule of thumb: up to 15 times greater. The RTB quality can yield load cycles of up to 300,000.

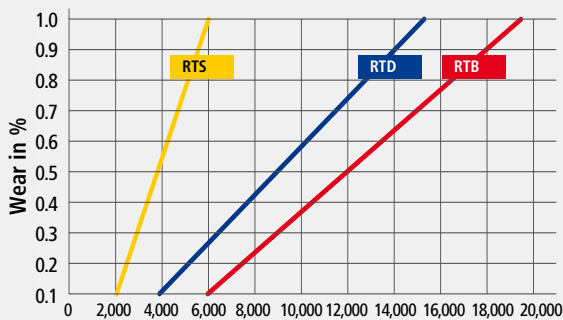

The quality classes relate to material, chain design and production process. Values given in case of test stand testing. Drive wheel, chain guide and scraper all designed and fabricated to the state of the art.

Tip: For RT chains, the load change number < 1,000. Conditions such as abrasive dust reduce the load change number for all chains.

SURFACE HARDNESS AND HARDNESS CURVE

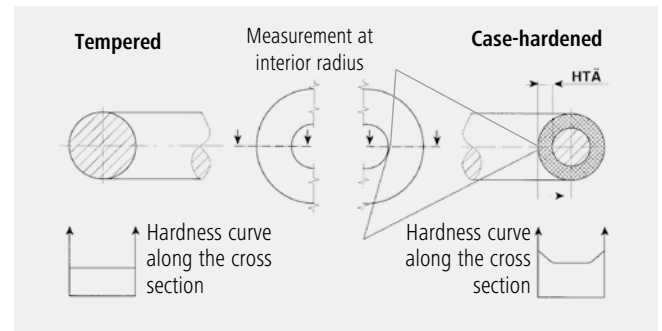

EXAMPLE HARDNESS CURVES

RTS quality = conventional heat treatment, low case-hardening depth
RTD quality = modified fabrication process
RTB quality = chain with especially high wear resistance. In addition, this quality is optimised for vibration resistance.

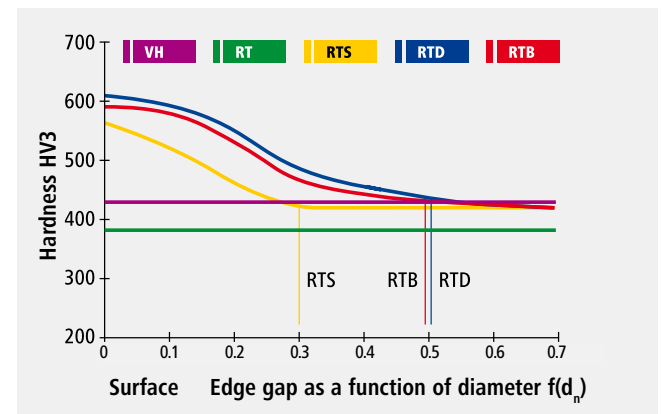

TRACTION - STRETCH DIAGRAM

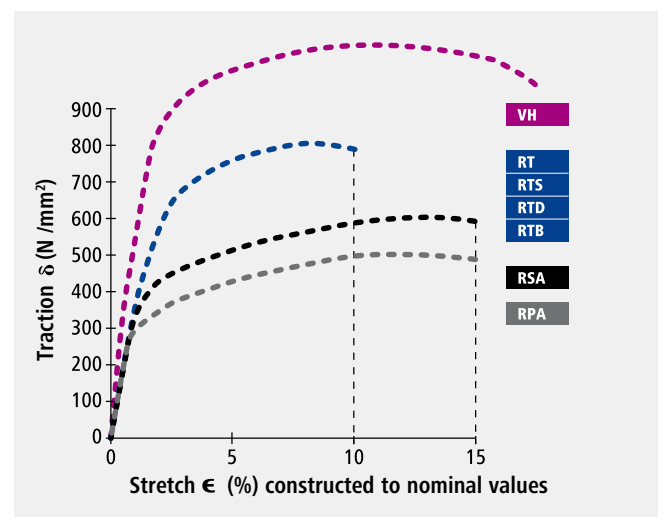

THE FUCHS LUBRICANTS GERMANY GMBH LISTED BELOW HAVE PROVED THEIR VALUE FOR LUBRICATING HOIST CHAINS IN PRACTICE.



STABYLAN 2001 Partly synthetic lubricant with creep and outstanding lubricating qualities, as well as excellent corrosion proofing. Application range -15°C to +150°C. Available as spray, open canisters or drums. Tried and tested **standard RUD lubricant** for general applications.

CEPLATTYN 300 Graphite paste with high-pressure and adhesion agents, creates an almost dry dust-repellent solid lubricant film, application from -30°C to +250°C. Available in open containers or as spray. **For use per mining hygiene regulations (GesBergV) above and below ground.**

STABYLAN 5006 Fully synthetic high temperature chain lubricant (chain honey) **for extreme temperatures up to 240°C.** Salt water-resistant, mineral oil resistant, penetrates and displaces water, outstanding adhesion. Available as a spray, in canisters and drums.

CASSIDA CHAIN OIL 1500 Fully synthetic high performance chain lubricant with very good adhesion and extreme resistance to being washed off. Temperature range -10°C to +140°C. Available in canisters, drums, or as a spray. Listed per NSF H1 and suited **to use in the vicinity of food.** Especially suited to meat processing applications, approved for KOSHER and HALAL processing.

DECORDYN 350 High adhesion corrosion proofing film with good lubrication qualities, for temperatures -40°C to +70°C. Used in **wind power installations, offshore and for general protection in aggressive environments.**

YOUR CONSULTANCY PARTNER

FUCHS LUBRICANTS GERMANY GmbH Phone: +49 (0) 621 3701-0
 Friesenheimer Str. 19 Mail: zentrale-flg@fuchs.com
 68169 Mannheim Web: www.fuchs.com

CHAIN LUBRICATION - AN IMPORTANT CONTRIBUTION TO REDUCING WEAR

WITHOUT CHAIN LUBRICATION LOAD CYCLES WITH UNLUBRICATED CHAIN:

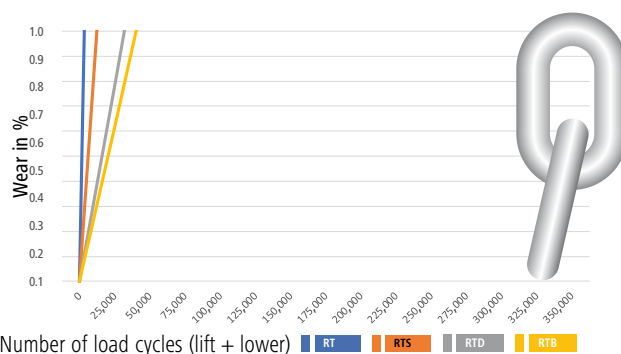

- When running over drive and reversing wheels, the chains links are angled under load.
- In order to minimise the resulting joint friction, hoist chains should be lubricated at regular intervals according to the conditions of use.

The indicated load cycles are achieved with an ungreased chain with load traction force of 100 N/mm², pocket wheel Z = 5 and speed V = 8 m/min.

REGULAR CHAIN LUBRICATION LOAD CYCLES WITH LUBRICATED CHAIN:

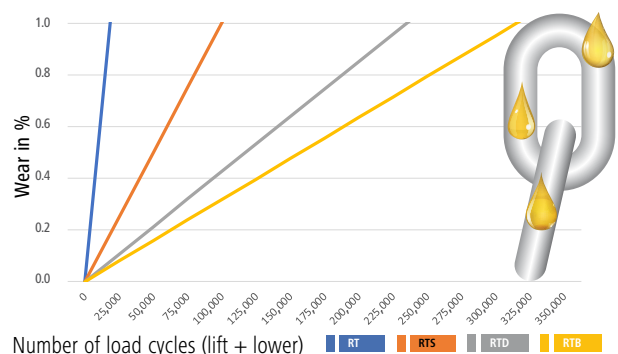

- Through a regular lubrication a 15-20 times higher number of cycles can be obtained than with a dry, unlubricated chain.
- During lubrication, ensure that the lubricant penetrates into the chain links most susceptible to wear.

The indicated load cycles are achieved with an unlubricated chain with load traction force of 100 N/mm², pocket wheel Z = 5 and speed V = 8 m/min.



RUD Ketten
Rieger & Dietz GmbH u. Co. KG
Friedensinsel
73432 Aalen / Germany
Phone +49 7361 504-1382
Mail: hoistchains@rud.com
Web: hoistchains.rud.com

